



*Electric examination couch*  
**SIMPLEX range**  
**SIMPLEX-2.0-700**

**CARINA**  
*Medical*



**CE**  
ISO 9001  
ISO 13485

## TECHNICAL DETAILS

- 2 sections examination couch, width 70cm
- Control : Pedal
- Backrest adjustment in every positions with gas jack
- Flat upholstery with good density 24kg/cm<sup>2</sup>, M1 fire retardant class, thickness 6cm
- Equipped with paper roll holder for exam sheet, on the foot side
- Epoxy covering, silver colour

## DIMENSIONS

- Width 70cm
- Adjustable height from 56 to 86cm
- Load capacity : 150kg in dynamic

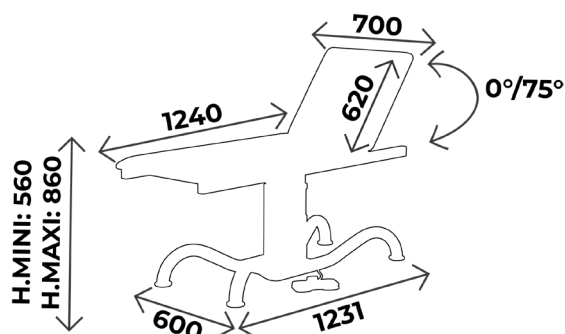

### You may also like :

Ref. **SIMPLEX-2.0** : Same as SIMPLEX-2.0-700 but width 60cm



## WHAT YOU NEED TO KNOW

- ✓ Delivery time: 15 days upon receipt of order
- ✓ Warranty : 2 years (1 year for the upholstery)

## ACCESSORIES



**ACC 990-SIMPLEX**  
Set of 4 wheels with brake  
diam. 75mm



**ACC 76C**  
Unit clamp to fix infusion stand  
diam. 16mm



**ACC 110**  
Blood test splint in colour  
without clamp, the unit

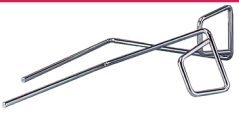

**ACC 105**  
Pair of stainless steel stirrups  
diam. 14mm, without clamp



**SLFEMIREPOSE**  
Cover for legrests (ACC964)  
in upholstery, the unit

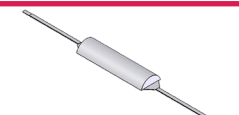

**ACC 54002**  
Half moon head rest width 70cm  
fire retardant M1 class



**ACCURGENCE03-70**  
Pair of retractable security side  
rails for SIMPLEX couch  
width 70cm



**ACC 832**  
Face hole with plug cushion



**ACC 538-700**  
Pair of clamps diam. 14mm for  
SIMPLEX range width 70cm



**ACC 32012**  
Stainless steel infusion stand  
diam. 16mm, 2 plastic hooks,  
without clamp



**ACC 110POLY**  
Polyurethane blood test splint  
without clamp, the unit



**ACC 964**  
Pair of legrests on knee system  
in black polyurethane  
diam. 14mm, without clamp



**ACC 514-UNIVERSE**  
Plastic protection cover  
for all couches



**ACC TETERGO**  
Ergonomic head rest



**ACC BARRILITCOM**  
Pair of retractable security side  
rails

# UPHOLSTERY'S COLOURS

Fire retardant  
upholstery, M2 class

For the upholstery colours, you can choose between the Ecomax, Classic and Urban range  
Be careful ! Classic and Urban colours **with extra value**

## *Upholstery : ECOMAX\* range*



Galapagos



Bahamas

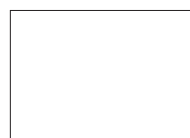

Blanc



Tahiti



Malouines

\*Standard colors for ECOMAX and SIMPLEX range,  
Classic and Urban colors **on demand**



# UPHOLSTERY'S COLOURS

Fire retardant  
upholstery, M1 class

For the upholstery colours, you can choose between the Classic and Urban range  
Be careful ! Classic and Urban colours **with extra value**

## *Upholstery : Classic range*



Arno



Garonne



Potomac

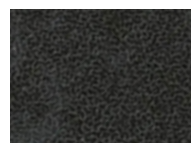

Amour



Mississippi

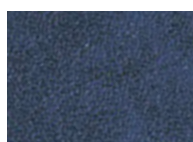

St Laurent



Rhône

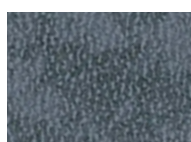

Missouri



Seine

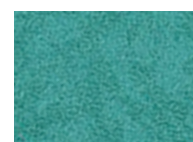

Amazone

## *Upholstery : Urban range*



Abysses



Cendre



Origan



Géranium



Régliasse



Prune

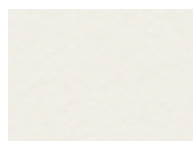

Perle

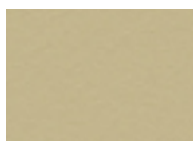

Ficelle

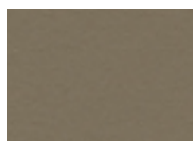

Terre

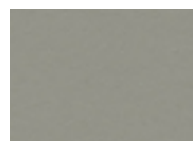

Béton

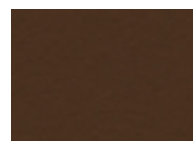

Chataigne

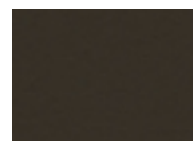

Chocolat

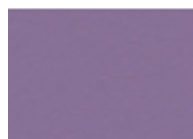

Pensée



Pétrole



Turquoise



Granny



Absinthe



Ananas



Orange



Fuschia



Tomate



# MAINTENANCE GUIDE

## **DAILY MAINTENANCE**

Upholstery : Cleaning with soapy water only (no solvents), can be disinfected with products such as Phagosept Spray, Salvanios pH10 at 0.75% and Anios Surfaces Hautes, without abrasive material

Base : cleaning with soapy water only (no solvents) without abrasive materials

## **WARRANTY**

Mechanical/ electrical part : 5 years

Upholstery : 1 year



**CONTACT**

**CARINA**  
*Médical*

Parc d'entreprises Visionis  
278 rue de l'industrie  
01090 GUÉREINS- FRANCE

**COMMERCIAL DEPARTMENT**

Tél : +33(0)4 74 66 69 49  
Fax : +33(0)4 74 66 69 50  
[export@carinamedical.com](mailto:export@carinamedical.com)